

ASYNCHRONOUS MOTORS

THREE-PHASE MOTORS
SINGLE-PHASE MOTORS
BRAKE MOTORS



OPERATING INSTRUCTIONS 2018

Read these Operating Instructions before you transport, install, commission, maintain or repair industrial motors or generators.

These symbols will draw your attention to the safety measures and additional instructions given in these Operating Instructions.

Special instructions regarding safety and warranty:



Danger:

For reasons of protection of persons and objects, all the safety measures and additional instructions given in these Operating Instructions must be strictly complied with.



Low-voltage machines have dangerous rotating and conductive parts, as well as possibly hot surfaces. All transport, installation, commissioning, maintenance and repair works have to be carried out exclusively by qualified personnel and checked by responsible experts (observe VDE 0105; IEC 364).



Inappropriate use may cause major damage to persons and objects.

Should additional data be required, you should immediately consult the manufacturer or an authorized service workshop.



All work on electrical connections to the motors and generators should only be carried out by qualified personnel.

GENERAL INFORMATION

SCOPE

These instructions refer to surface-ventilated three-phase and AC low-voltage cage induction motors and generators, IP 54 and IP 55 to DIN VDE 0530, part 5, EN 60034 and IEC 34-5. Higher degrees of protection are indicated on the rating plate.

These low-voltage machines are intended for industrial installations. They comply with the harmonized standards DIN VDE 0530/EN 60034. Observe any possible special prescriptions for their use. Air-cooled low-voltage machines are designed for operation at altitudes ≤ 1000 m above sea level and at ambient temperatures between -20°C and $+40^{\circ}\text{C}$. Exceptions are stated on the rating plate.



Observe especially different indications on the rating plate. The conditions at the place of use must coincide with all the data of the rating plate.

The low-voltage machines are components of a machine according to the Directive Machines 2006/42/CE. The commissioning of this machine is forbidden until conformity of the final product with this directive is proved (observe EN 60204-1).

TRANSPORT

Should any damage be observed after delivery of the low voltage machine at its destination, these should be notified immediately to the transport company; avoid commissioning.

LIFTING EYES



Lift motors only on lifting eyes provided. Do not add any load to the motor. Lifting eyes are designed for the motor mass only. Should it be necessary, use appropriate cable guides.

ROTOR LOCKING DEVICE



Motors with roller bearings are protected against bearing damage during transport by means of a locking device which has to be removed before putting the motor into operation.

Close the fixing hole by means of the plug supplied. The locking device must also be used for any further transport of the motor.

VENTILATION

The distance between air intake of the motor and walls or other machinery must be at least $\frac{1}{4}$ of the diameter of the air intake opening. Cooling air flows from the non-drive end towards the drive end. Air leaving the motor must not be drawn in again by the fan. Keep air inlets and outlets clean.



For vertical shaft-up designs, suitable protection must be provided at the mounting end so that no foreign matter can enter the ventilation hole. Such protection must, however, not affect the cooling and air leaving the motor/generator - or adjacent groups - must not be drawn in again.

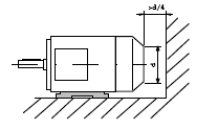

CONDENSATION DRAIN HOLES

Even after installation the condensation drain holes must be at the lowest point of the motor. They must be kept clean. Plug drain hole after each drainage.

INSTALLATION AND COMMISSIONING

MECHANICAL

TRANSMISSION ELEMENTS



Use elastic couplings only; rigid couplings require a special bearing design.

When using transmission elements which provoke radial or axial shaft loads during operation (e.g. pulleys, gearwheels, etc.) take care that the permissible loads are not exceeded. Relevant data are given in the respective technical catalogue.

Rotors are at present dynamically balanced with half key. (As per DIN ISO 8821).

«H» or «blank» means balanced with half key

«F» means balanced with full key

«N» means no key

When the motor is balanced with a half key (H), the coupling has also to be balanced with half key; machine the overhanging visible part of the key.

Remove anti-corrosion paint by means of a suitable solvent and grease the shaft extension. Use only suitable tools to mount or pull off pulleys or couplings, see Fig. 1-3, (heat to $80-100^{\circ}\text{C}$) and cover with a protection against accidental contact.

Avoid inadmissible tension of the belts (technical catalogue).

By no means the bearings may be subjected to any pressure or shock.



Remove fancover

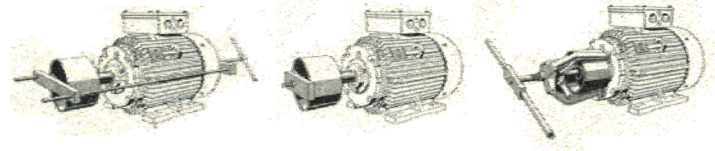



Fig. 1 Mounted without female thread

Fig. 2 Mounted with female thread

Fig. 3 Pulling off

SUBSTRUCTURE

Make sure that the feet or flanges are safely fixed and rest positively on their entire surface. Check also the exact alignment with direct coupling.

 All motor feet must rest positively on their entire surface to avoid distortion of the motor frame.

Avoid resonance of the base with the turning frequency and double mains frequency. Turn the rotor by hand. Check the direction of rotation with the machine uncoupled (see "Vibrations during operation").

ALIGNMENT

When the motor is connected to the driven machine via a coupling, the shafts must be aligned radially and axially to each other. The dial gauges must be firmly secured. Measurements have to be taken at four points, displaced by 90°, while both coupling halves are turned simultaneously.

ANGULAR ALIGNMENT (FIG. 4)

Deviations are to be equalized by means of shims placed under the motor feet. Permanent inaccuracies must not exceed 0.03 mm, referred to a diameter of 200 mm.

PARALLEL ALIGNMENT (FIG. 5)

Deviations are to be equalized by placing shims under the motor. The remaining inaccuracies must not exceed 0.03 mm. The adjustment of the axial clearance between the coupling halves (dimension «E») is to be effected in accordance with the coupling manufacturers specification.

 Re-check alignment with the machine at operating temperature.

COMBINATION OF ANGULAR AND PARALLEL ALIGNMENT (FIG. 6)

Fig. 6 shows a relatively simple method of combining the two measurements. The dial gauges are inserted into the corresponding screwed or clamped flat iron holders (e.g. by set screws).

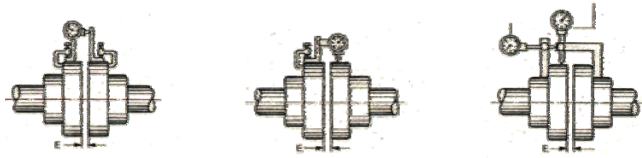



Fig. 4 Angular alignment
 Fig. 5 Parallel alignment (centre offset)
 Fig. 6 Parallel – Angular alignment

VIBRATIONS DURING OPERATION

Vibration levels $V_{eff} = \leq 3.5$ mm/s ($P_N \leq 15$ kW) or 4.5 mm/s ($P_N > 15$ kW) of the coupled machine are not problematic. When there are differences in comparison with normal operation, such as higher temperature, noise, vibration, determine the cause and, if necessary, consult the manufacturer.

 Do not switch safety devices off, not even when test running. In the case of doubt, disconnect the machine.

ELECTRICAL

INSULATION RESISTANCE
 (see "Check before commissioning")

VOLTAGE AND WINDING CONNECTION

The admissible fluctuation between rated voltage and supply voltage is $\pm 5\%$; for rated frequency, $\pm 2\%$ is allowed. Observe different connection indications and data on the rating plate, as well as the connection diagram in the terminal box.



CONNECTION

Choose cable cross-sections in accordance with the rated current. Not used cable entries must be closed by compression glands. The terminal box can be turned by 90° or 180°.



Work should only be carried out by qualified personnel, always with the machine out of operation, disconnected and previously secured against starting. This is also valid for auxiliary circuits (e.g. heaters). Make sure that there is no voltage!

The supply cables must be connected with special care to ensure permanent and reliable contact (without loose cable ends); use suitable terminals for the connection cables.

Supply cables must be stress-relieved so that no cantilever loads are exerted on the terminals.

 Ensure a good connection of the protective conductor.
 The minimum safety distances between conductors and between those and earth should not exceed the following values: ≤ 550 V 8 mm; ≤ 750 V 10 mm; ≤ 1100 V 14 mm.

Make sure that no foreign matter is left in the terminal box, and that it is clean and dry. Cable entries which are not used and the terminal box itself have to be sealed dust and water-tight. In order to maintain the degree of protection, always make sure that the original gaskets are used when closing the terminal box.

 Connect protective conductor here.
 For the test run without drive elements, secure the key. Before commissioning brake motors, make sure that the brake is operating correctly.

DIRECTION OF ROTATION

Normally, the motors are suitable for both directions of rotation. Exceptions are indicated on the rating plate by an arrow. For the desired direction of rotation, the stator winding is connected as follows:

Connection	
L1, L2, L3 to	Direction of rotation when viewing drive end
U1, V1, W1	Clockwise
W1, V1, U1	Counter-clockwise

 Check of the direction of rotation, see below.

REVERSING THE DIRECTION OF ROTATION

Mode of starting and winding	Measures
Direct-on-line starting and pole-changing motors with separate windings	Exchange two supply-cable conductors on the terminal board of the motor
Star/delta starting and pole-changing motors with Dahlander winding	Exchange two supply-cable conductors at the incoming supply to the contactor combination

TEST

To check the direction of rotation, switch the properly connected but uncoupled motor quickly ON/OFF.

Y/Δ STARTING

In order to avoid excessive transient currents and torques, before changing over from Y to Δ, wait until the starting current of the Y stage has died down or run-up has concluded (e.g. change over when rated speed is reached).

MOTOR PROTECTION

Connect semiconductor temperature detectors to the release device in accordance with the wiring diagram. Continuity test, if necessary, to be carried out by means of a measuring bridge only (max. 2.5 V).



In order to achieve full thermal protection, an additional thermally delayed overload protection must be installed (Fig. 7). Normally, fuses alone protect only the supply system not the motor.

Example

Contactors with over current relay
Thermistor protection and fuse

Fig. 7

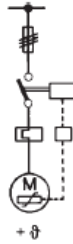

MAINTENANCE



Before carrying out any work on the motor, disconnect it and secure it against restarting.

Exception: In motors with greasing device, regrease the bearings with the motor running.



Caution, danger of accidents: Take care not to come in contact with moving parts!

CLEANING

Depending on the local conditions, air passages should be cleaned regularly.

BEARING LUBRICATION



Observance of regreasing intervals is vital for the operational reliability of the motor!

MAINTENANCE OF BEARINGS

BALL BEARING WITH PERMANENT LUBRICATION

Under normal operating conditions, motors can be operated for about 20,000 hours without maintenance.

However, the maximum period of maintenance-free operation is four years. The ball bearings and the bearing caps should then be washed with petrol or benzene. If necessary, replace the bearings. Fill the spaces between the balls and the roller tracks as well as the grease compartments half with grease. Coat shaft bushings in the bearing caps or endshields with a thin layer of grease.

Permanently greased bearings (2RS and 2Z bearings) cannot be washed and regreased. Such bearings must therefore be replaced.

To dismantle the bearings, use pressing screws or other appropriate devices.

BALL BEARINGS WITH REGREASING DEVICE AND GREASE SLINGER

Regreasing interval and required quantity of grease is indicated on the rating plate. Bearings and bearing caps must be washed with petrol or benzene when they have been regreased twelve times.



Used petrol or benzene in air-tight tanks should be disposed of as special refuse with the marking «Petrol» or «Benzene».

Afterwards, with the outer bearing cap open but the inner cap screwed on, the rotor should be turned slowly and grease pressed in through the regreasing device until approximately half the empty space between the rolling elements and the roller tracks is filled with grease.

If a grease with a different soap base is to be used, clean bearing seats thoroughly.



Make sure that the bearing grease used meets the following requirements:

Pour point approx.	190° C
Ash content	4 %
Water content	0.3 %

LUBRICANT

Grease K 3 N to DIN 51825 (lithium-based, water resistant to DIN 51807 Part 1, grade 0 or 1). Regrease only with a similar grease (e.g. Esso Unirex N 3, Shell-Alvania G 3, Esso Beacon 3, etc.).

REPAIR INSTRUCTIONS

Any repair work within the guarantee period is subject to the approval of the motor manufacturer.

GENERAL



It is strongly recommended that only original spares be used for motor repairs. It is work which do not affect the explosion protection and is, therefore, not subject to special regulations.

- e.g.
- Replacement of gaskets or joints
 - Repair or replacement of fan or fan cover
 - Replacement of bearings
 - Replacement of terminal board

SPECIAL REPAIRS

It is work which can affect the explosion protection, e.g. work on stator or rotor windings. Unless the repair is carried out by ourselves, the proper execution of the work in accordance with the relevant regulations must be certified by an authorized expert.

According to EN 50019 or EN 50014, any repair of this kind must be stated on an additional plate, permanently fixed to the motor.

INSTRUCTIONS FOR STORAGE OF MOTORS

For prolonged storage of electric motors (e.g. spare motors), the following precautions must be observed:

PLACE

Make sure that they are kept in a dry and dust free place with minimum vibration ($V_{eff} \leq 0.2$ mm/s) (damage to stalled bearings). Ambient temperature + 10° C to + 40° C, relative humidity < 50 %.

ROTOR LOCKING DEVICE

On motors with roller bearings, fix the rotor in place by means of the locking device, to protect the bearings against damage due to vibration.

Motors shipped on vibration dampers should also be stored in this condition.

Where pulleys, half couplings, etc. are already mounted on the shaft extension, fit the locking device or place the motor on vibration dampers, if possible.



Use dampers and locking device also for any future transport of the motor.

CHECK BEFORE COMMISSIONING

BEARINGS

Before commissioning a motor that has been stored for more than 4 years, check the bearings.

For motors without regreasing device, grease has to be renewed or bearings have to be changed after 2 years at the latest.



Even minor corrosion can considerably shorten the service life of the bearings. Bearings that need not be replaced should be packed with new grease.



For grease type and quantity, refer to the rating plate (on the motor) and to «Bearing lubrication, Lubricant» on page 6 of this Operating Instructions.

Motors with regreasing device have to be regreased after 2 years at the latest with the double quantity of grease indicated on the nameplate. Hereby the rotor has to be rotated. When motors are stored for over 4 years, change grease.

The rotor has to be rotated every month by approx. 30 degrees, in order to avoid compression spots on the bearings due to static load.



For rotating the rotor loosen, but not remove the locking device fitted. After the rotation procedure, retighten the locking device.

INSULATION RESISTANCE



Before commissioning check the insulation resistance. With values $\leq 1\text{k}\Omega$ per Volt rated voltage, dry the winding.

Check the insulation resistance of each phase against earth by means of a hand-driven generator (max. 630 V DC) until the measured value is constant. The insulation resistance of new windings is above $10\text{ M}\Omega$. The resistance can be lowered considerably by moisture.

If, at room temperature, the resistance is below $0.5\text{ M}\Omega$, the winding must be dried. In this case the winding temperature must not exceed 80°C .

For drying connect the space heater or another heating device, or apply an AC voltage of 5 or 6 % (connect in delta) of the rated motor voltage to terminals U1 and V1. Repeat the measurement. The motor can be put into operation when the resistance is above $0.5\text{ M}\Omega$.

Insulation resistance is temperature-dependent, i.e. if the temperature is increased/decreased by 10 K, the resistance value is halved/doubled, respectively.

WIRING DIAGRAMS

THREE-PHASE CAGE MOTORS

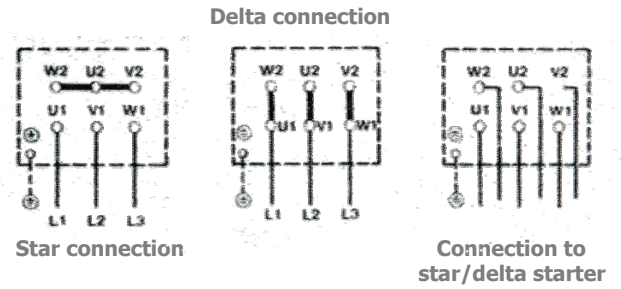

Three-phase pole-changing motors: In Dahlander connection: In the type designation the low number of poles = high speed is shown first (e.g. BP 100 ... 4/8)

With 2 separate windings: In the type designation the low number of poles = high speed is shown first (e.g. BP 100 ... 4/8)

For pole-changing motors please observe the wiring diagram in the terminal box of the motor.

SINGLE-PHASE CAGE MOTORS

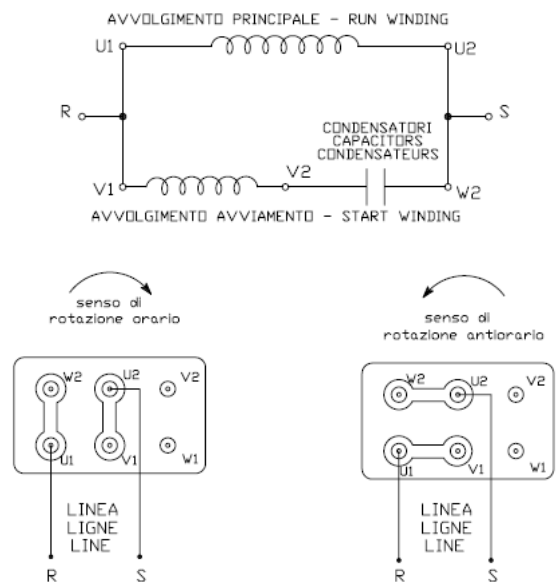

WARNING FOR THE CORRECT DISPOSAL OF THE MOTORS AT THE END OF THEIR LIFE TIME



**According to the art. 26 of the Italian law 2014, March 14th n. 49
" Implementation of the DIRECTIVE 2012/19/EU OF THE EUROPEAN PARLIAMENT AND OF THE COUNCIL
of 4 July 2012, on waste electrical and electronic equipment (WEEE)"**

The above symbol, applied to the equipment or its packaging, means that at the end of its lifetime the motors need to be disposed separately from the other waste materials.

The users must dispose their unused motors on behalf of the national authorized collection centers which have been approved for the electrical and electronic waste.

The right collection for recycling, treatment and disposal will contribute to avoid any potential negative environmental & healthy effect, and will help both the reuse and the recycling of the motor' components/materials.

TABLE OF DISPOSAL CODES FOR ELECTRIC MOTORS

CODE OF THE MOTOR (WASTE) DISPOSED IN ALL ITS PARTS	EWC (European Waste Code)	EWC DESCRIPTION
In the event of disposal of the full motor	16.02.14	Discarded equipment
In the event of disposal of a disassembled motor: <ul style="list-style-type: none"> • <i>Aluminium parts:</i> flange, cover, terminal box and frame in aluminium • <i>Steel parts:</i> rotor with shaft (both die-cast and with magnets), stator pack with wire windings, cast iron flange and cover, terminal box, brake with magnet, friction disc, springs, etc. • <i>Plastic parts:</i> fan, fan cover, terminal box, brake cover, shaft protection • <i>Electrical components:</i> switches, capacitors, starters, terminal board, etc. 	12.01.03 12.01.01 12.01.05 16.02.16	Non-ferrous metal filings and turnings Ferrous metal filings and turnings Plastics shavings and turnings Components removed from discarded equipment



ICME S.p.A.

Via Santa Barbara, 143

I-48010 Fusignano (Ravenna), Italy

Tel. +39 / 0545 950 011 | Fax +39 / 0545 52 403

info.icme@lafert.com

www.lafert.com